

Softline

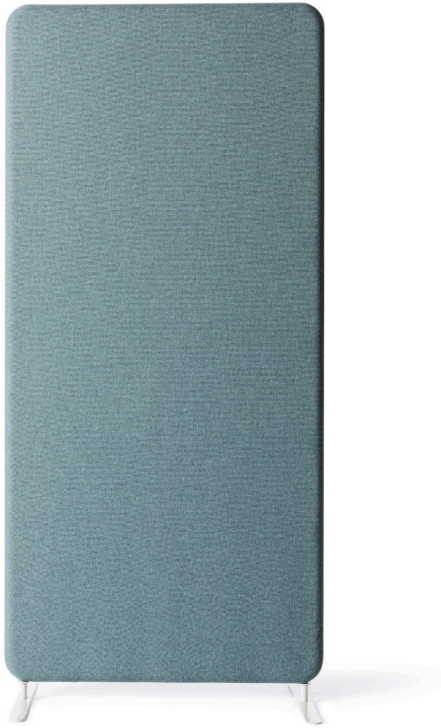

Softline



I arbetsmiljöer med hög ljudbelastning ger Softline högsta möjliga ljudabsorption över hela sin yta.

Skärmen passar t ex utmärkt i öppna kontorslandskap, då det finns möjlighet att skapa små avskilda platser.

In high-noise working areas, Softline gives a high level of sound absorption on total screen surface.

The screen is suitable for open office landscapes - with these you have the possibility to create smaller, separated work spaces.



Softline är enkla stilrena skärmar där tyget avgör uttrycket. Stort urval av tyger!

Softline is simple stylish screen where the fabric determines the expression. Large selection of fabrics!



Bordskärmen finns i flera varianter; monterad över bordskant alt. nedhängande samt mobil, fristående skärm.

The screen is available in several performances: attached over the desk, modesty panel or as a mobile, free-standing screen.



Golvskärmen finns i två olika tjocklekar: 30 och 50 mm.

The floor screen is available in two different thicknesses: 30 and 50 mm.



Absorption Dämning





Teknisk information/Technical information

Softline golvsskärm/Softline floor screen

Golvsskärm, d30 eller d50/
Floor screen, d30 or d50/

b×h×d/w×h×d mm
800×1360×50
1000×1360×50
1200×1360×50
800×1500×50
1000×1500×50
1200×1500×50
800×1700×50
1000×1700×50
1200×1700×50

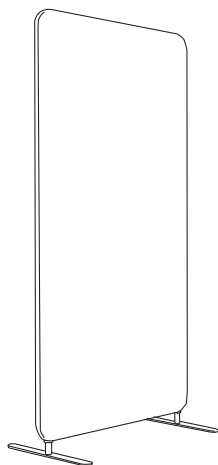

Softline bordsskärm/Softline table screen

Rak h450 alt.590 x d30 mm
Rectangular

bredd/width mm
600 1200 1800
800 1400 2000
1000 1600

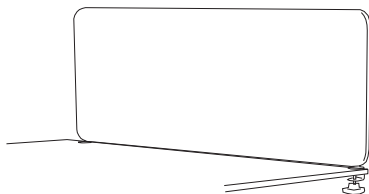

Nedhängande h650 x d30 mm/
Modesty panel

bredd/width mm
600 1000 1600
800 1200 1800
830 1400 2000

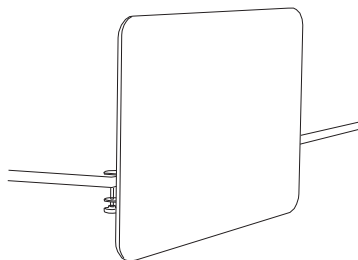

Mobil bordsskärm h450 x d30 mm/
Mobile table display

bredd/width mm
600 1200
800 1400
1000 1600

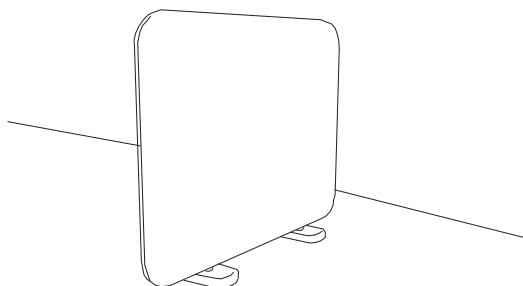

Kopplingar och väggbeslag/Connectors and wall fittings

För att koppla ihop skärmar behövs två 40 mm kopplingar till varje skarv, en upptill och en nedtill. För att fästa en skärm i väggen används väggfästen och 3-vägskopplingar.

Two 40 mm connectors one at top and one at the bottom are used to connect two screens. Wall brackets and 3-way connectors are used to connect screens to a wall.

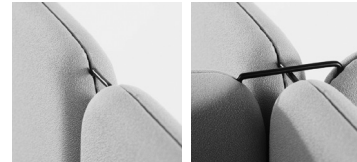

Softline benpaket/Softline leg set

Benpaket 50mm/Leg set 50mm

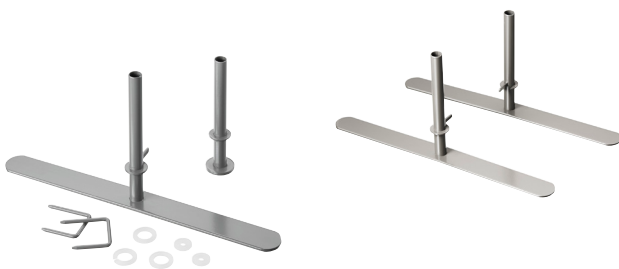

Benpaket finns även med hjul (höjd 65 mm)/Also available with wheels (height 65 mm)

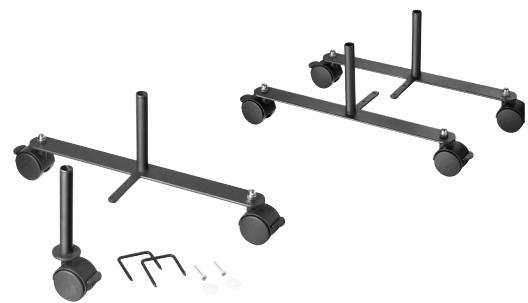

Tillbehör Softline/Additional shelving Softline

Softlines nya tillbehör: hyllor i transparent akryl med ett minimalistiskt uttryck. Tillbehören finns i tre olika utföranden: pennkopp, hylla och postfack som enkelt hängs på skärmens övre kant.

Softline is gaining a new accessory: shelving in transparent acrylic with a minimalist style. The shelving is available in three different designs: penholder, shelf and pigeonhole, and they are simply hung over the top of the screen.









abstracta

info@abstracta.se
www.abstracta.se