

Pavilion AV9, AV10 & AV15

Anderssen & Voll

2018

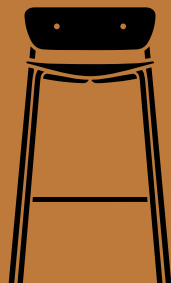



AV9 & AV10

# Recycling & Disassembly

Pavilion <sup>AV9 & AV10</sup>

## RECYCLING

The Pavilion chair is built to last, and we hope that your Pavilion will serve you for many years. The chair is made from wood veneer and powder coated steel, and can be easily separated from its base. All metal and wooden parts can be separated and delivered to a suitable recycling station.

## SPARE PARTS

To purchase spare parts for your Pavilion chair, please write to our sales support team at [info@andtradition.com](mailto:info@andtradition.com) with your query.

## 5 YEAR WARRANTY

&Tradition provides a 5-year warranty with every Pavilion chair, which covers faults which were present at the time of purchase, or which have occurred as a result of a manufacturing defect. The warranty is valid from the date stated on the original invoice.

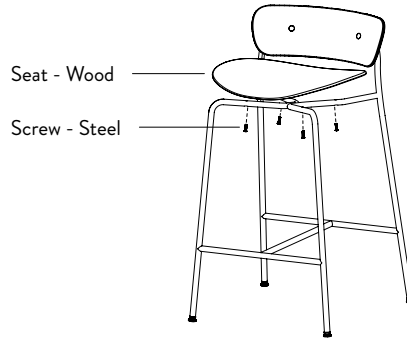

## DISASSEMBLY

### Disassembling of Pavilion counter and bar chair

1. Unscrew the screws underneath the chair to remove the seat.

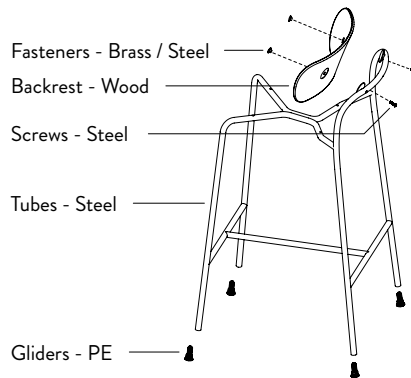

2. Unscrew the screws behind the back of the chair, to remove the backrest and fasteners.

3. Remove the gliders.

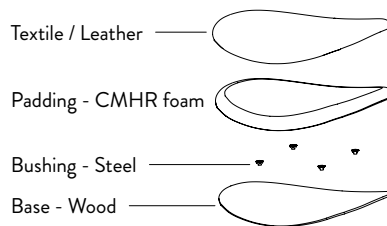

### Disassembling of upholstered seat (AV10 only)

Remove the textile, padding and bushings from the wooden base of the seat.



AV15

# Recycling & Disassembly

Pavilion<sup>AV15</sup>

## RECYCLING

The Pavilion chair is built to last, and we hope that your Pavilion will serve you for many years. The chair is made from wood veneer and powder coated steel, and can be easily separated from its base. All metal and wooden parts can be separated and delivered to a suitable recycling station.

## SPARE PARTS

To purchase spare parts for your Pavilion chair, please write to our sales support team at [info@andtradition.com](mailto:info@andtradition.com) with your query.

## 5 YEAR WARRANTY

&Tradition provides a 5-year warranty with every Pavilion chair, which covers faults which were present at the time of purchase, or which have occurred as a result of a manufacturing defect. The warranty is valid from the date stated on the original invoice.

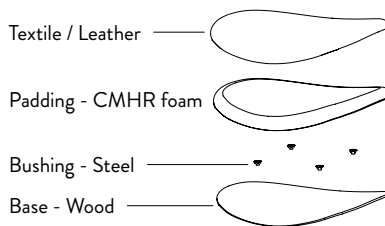
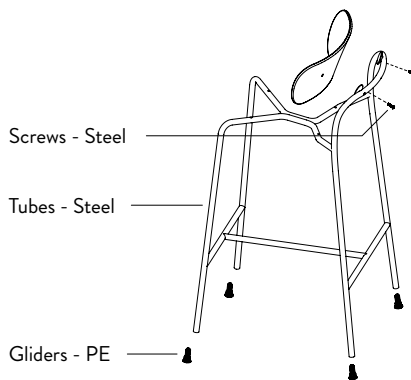
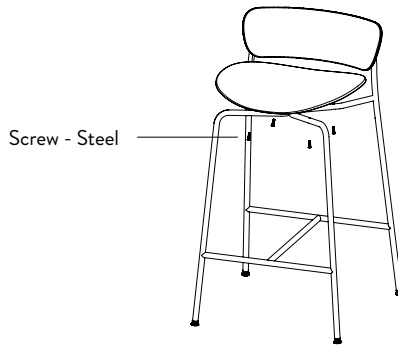

## DISASSEMBLY

### Disassembling of Pavilion counter and bar chair

1. Unscrew the screws underneath the chair to remove the seat.
2. Unscrew the screws behind the back of the chair, to remove the backrest.
3. Remove the gliders.

### Disassembling of upholstered seat & backrest

1. Remove the textile, padding and bushings from the wooden base of the seat.
2. Do the same with the backrest of the chair.

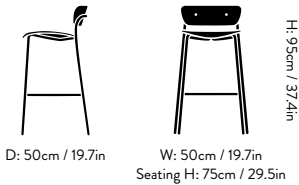

# Pavilion<sup>AV9</sup> Anderssen & Voll 2018

## Product category

Bar chair

## Environment

Indoor

## Material

Steel tubes and formpressed veneer.

This product has not been treated with any biocides.

## Production process

The chair is made from bend steel tubes and formpressed veneer. The veneer back and are finished with a PU lacquer.

## Dimensions

H: 95cm/37.4in, D: 50cm/19.7in,  
W: 52cm/20.5in, Seat height: 75cm/29.5in

## Package dimensions

H: 97cm/38.2in, D: 51cm/20.1in, L: 55cm/21.7in

## Colli quantity

1 pc

## Weight

Product: 5.0 kg / Incl.packaging: 7.5 kg

## Base finishes

Black

## → Stock item

Lacquered Oak, Black Lacquered Oak, Lacquered Walnut

## Gliders

Plastic gliders installed as standard. Felt gliders available upon request (6-8 weeks lead time).

## Fittings

Black fittings for the front side of the back rest installed as standard. Brass fittings available upon request (6-8 weeks lead time).

## Strength, Durability and Safety Testing

The chair is tested for strength, durability and safety according to; EN 16139 Level 2 – Extreme use.

## Manufacturer

Produced in Latvia by Kvist Industries A/S

## Cleaning Instructions

Please download our Material Care & Cleaning Instructions through [www.andtradition.com](http://www.andtradition.com)

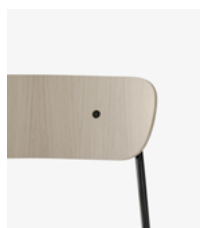

→ Lacquered oak

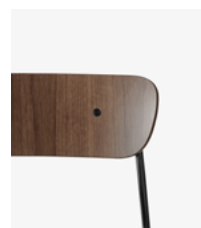

→ Lacquered walnut

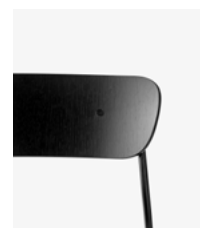

→ Black lacquered oak

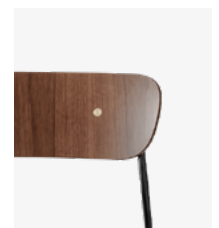

Brass fitting

## Related products

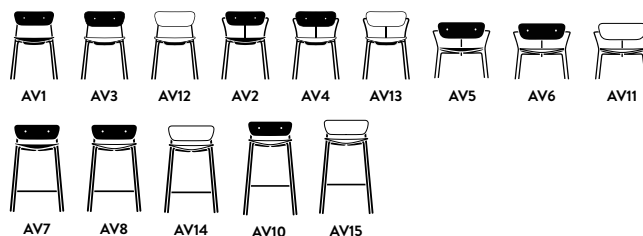

# Pavilion<sup>AV10</sup>

## Anderssen & Voll

### 2018

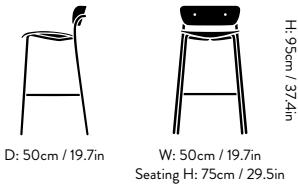

#### Product category

Bar chair

#### Environment

Indoor

#### Material

Steel tubes, formpressed veneer, HR foam, fabric or leather upholstery.

This product has not been treated with any biocides.

#### Production process

The chair is made from bend steel tubes and formpressed veneer. The veneer back is finished with a PU lacquer. The seat is covered with HR foam and upholstery for superior comfort.

#### Dimensions

H: 95cm/37.4in, D: 50cm/19.7in,  
W: 52cm/20.5in, Seat height: 75cm/29.5in

#### Package dimensions

H: 97cm/38.2in, D: 51cm/20.1in, L: 55cm/21.7in

#### Weight

Product: 5.3 kg / Incl.packaging: 7.5 kg

#### Base finishes

Black

#### Colours

Lacquered Oak, Black Lacquered Oak and Lacquered Walnut. Available in variety of fabrics and leather.

#### Gliders

Plastic gliders installed as standard. Felt gliders available upon request (6-8 weeks lead time).

#### Fittings

Black fittings for the front side of the back rest installed as standard. Brass fittings available upon request (6-8 weeks lead time).

#### COM - Material Consumption

Fabric usage: 0.45 meters based on 140cm roll.  
Leather usage: 0.55 square meters. COM must be approved by &Tradition to ensure suitability for upholstery on the chair.

#### Strength, Durability and Safety Testing

The chair is tested for strength, durability and safety according to; EN 16139 Level 2 – Extreme use.

#### Manufacturer

Produced in Latvia by Kvist Industries A/S

#### Cleaning Instructions

Please download our Material Care & Cleaning Instructions through [www.andtradition.com](http://www.andtradition.com)

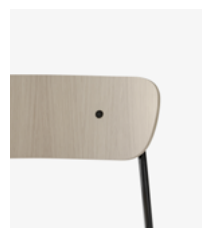

Lacquered oak

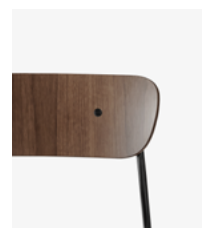

Lacquered walnut



Black lacquered oak

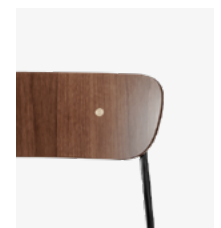

Brass fitting

#### Related products

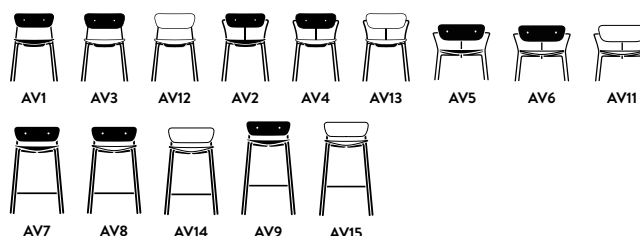

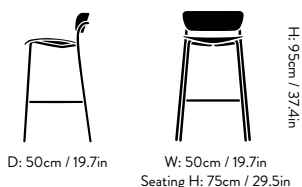

# Pavilion<sup>AV15</sup> Anderssen & Voll 2018

## Product category

Bar chair

## Environment

Indoor

## Material

Steel tubes, formpressed veneer, HR foam, fabric upholstery.

This product has not been treated with any biocides.

## Production process

The Pavilion bar chair is made from bend steel tubes and formpressed veneer. The seat and back are covered in HR foam for comfort with a fabric upholstery.

## Dimensions

H: 95cm/37.4in, D: 50cm/19.7in,  
W: 52cm/20.5in, Seat height: 75cm/29.5in

## Package dimensions

H: 97cm/38.2in, D: 51cm/20.1in, L: 53cm/20.9in

## Colli quantity

1 pc

## Weight

Product: 5.3 kg/ Incl.packaging: 7.8 kg

## Base finishes

Black

## Gliders

Plastic gliders installed as standard. Felt gliders available upon request (6-8 weeks lead time).

## COM - Material Consumption

Fabric usage: 0.8 meter based on a 140cm roll.  
COM must be approved by &Tradition to ensure suitability for upholstery.

## Strength, Durability and Safety Testing

The chair is tested for strength, durability and safety according to; EN 16139 Level 2 – Extreme use.

## Manufacturer

Produced in Latvia by Kvist Industries A/S

## Cleaning Instructions

Please download our Material Care & Cleaning Instructions through [www.andtradition.com](http://www.andtradition.com)



## Related products

